

Part Number: 250-1771
250-1769

Kit Contents

Item #	Quantity Req'd.	Description
1	1	OE-Style Cruise Switch
2		
3		
4		
5		
6		
7		
8		

Hardware Bag Contents

Item #	Quantity Req'd.	Description
1	2	Screw, Self Tapping
2	2	Terminal, Male, Insulated, Red
3	2	Terminal, Male, Insulated, Red
4	2	T-Tap, Female, Red
5	1	Clutch Switch
6	2	Harness, Clutch Switch
7	2	Connector, Butt Splice
8		

Additional Items Required For Installation

Item #	Quantity Req'd.	Description

Conflicts

Note:

Recommended Tools

Safety Tools	
Special Tools	
	OPTIONAL-SOLD SEPERATELY
250-2598	Tool, Cut, Switch Hole
250-2599	Tool, Template, Hole
250-2600	Tool, Extraction, Die
Installation Tools	
Torx 15, 30	
10, 13 mm Socket/Ratchet	
Philips Screwdriver	
Pliers	
Wire Strippers	
Special Chemicals	

Color Applicability/Trim Level

Accessory Color	Vehicle/Trim Color															

General Applicability







2005 Corolla/Matrix, TMMC, M/T ONLY

Recommended Sequence of Application

Item #	Accessory
1	
2	
3	

*Mandatory

Legend

-  **STOP:** Damage to the vehicle may occur. Do not proceed until process has been complied with.
-  **OPERATOR SAFETY:** Use caution to avoid risk of injury
-  **CRITICAL PROCESS:** Proceed with caution to ensure a quality installation. These points will be audited on a completed vehicle installation
-  **GENERAL PROCESS:** This highlights specific processes to ensure a quality installation. These points will be audited during the accessory installation
-  **TOOLS & EQUIPMENT:** This calls out the specific tools and equipment required for this process
-  **REVISION MARK:** This mark highlights a change in installation with respect to previous issue.

SPECIAL NOTE: Installation Sequences

After **Safety** mandated preparatory steps have been taken, the installation sequence is the suggested method for completing the accessory installation. In some instances the suggested sequence is written for one associate to install and in others the sequence is given as part of a team accessory installation. Unless otherwise stated in the document, the associates may perform the installation steps in any order to make the installation as efficient as possible while maintaining consistent quality.

PARTS IDENTIFICATION

ITEM	QUANTITY	PART NUMBER	DESCRIPTION
1	1	250-2647	TOOL, SWITCH, 3 PIECE (OPTIONAL-SOLD SEPERATLEY)
2	1	250-2598	TOOL, SWITCH, HOLE PUNCH (OPTIONAL-SOLD SEPERATLEY)
3	1	250-2599	TOOL, SWITCH, TEMPLATE (OPTIONAL-SOLD SEPERATLEY)
4	1	250-2600	TOOL, SWITCH, EXTRACTION (OPTIONAL-SOLD SEPERATLEY)
5	2	250-2651	SCREWS, SWITCH
6	1	250-1768	SWITCH, 2 SCREWS
7	1	250-2648	HARN, CLUTCH SWITCH
8	1	250-2649	HARDWARE
9	1	250-3372	CLUTCH SWITCH

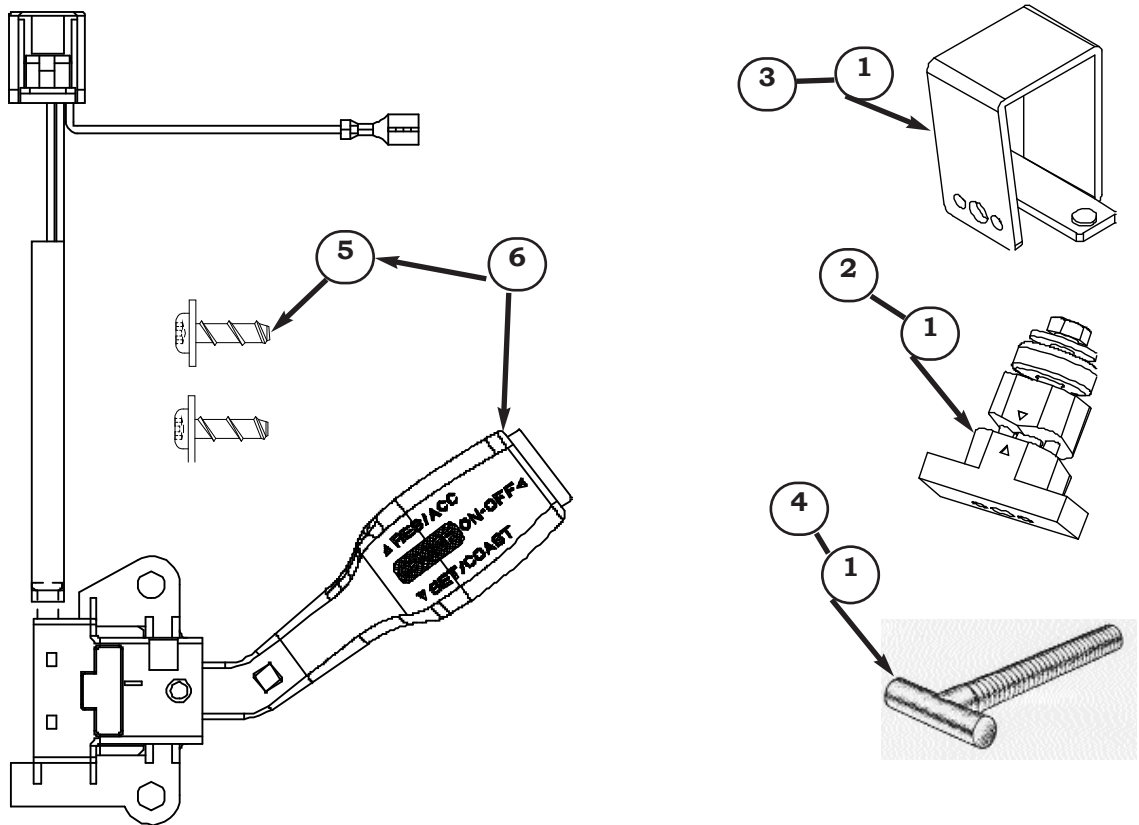
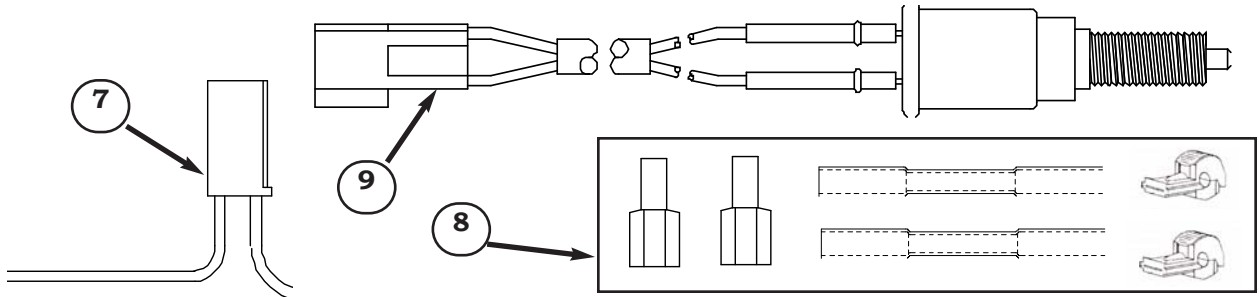

INSTALLATION

CONTROL SWITCH

LOCATION: RIGHT SIDE STEERING WHEEL COVER

HARDWARE: USE CUTTING TOOLS 250-2647 OR TEMPLATE INSTRUCTIONS

1. REMOVE LOWER STEERING COLUMN COVER; THIS REQUIRES REMOVAL OF THREE (3) PHILIPS SCREWS.
FIGURES 1, 2 & 3.



CAUTION: ENSURE THAT BATTERY HAS BEEN DISCONNECTED FOR MORE THAN 90 SECONDS PRIOR TO REMOVAL OF AIRBAG; FAILURE TO HEED THIS WARNING MAY RESULT IN AIRBAG DISCHARGE AND MAY CAUSE SERIOUS INJURY OR DEATH.



2. REMOVE AIRBAG BY EXTRACTING THE TWO 30 TORX SCREWS AS ILLUSTRATED IN **FIGURE 4A.**

3. UTILIZE SMALL SCREWDRIVER TO REMOVE AIRBAG CONNECTORS AS ILLUSTRATED IN **FIGURE 4B.**



CAUTION: BE SURE TO STORE AIRBAG FACE UP AS ILLUSTRATED IN FIGURE 4C TO REDUCE INJURY IN EVENT OF ACCIDENTAL DISCHARGE OF AIRBAG.

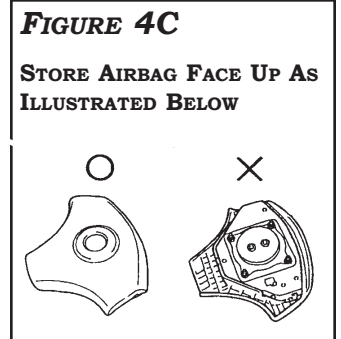
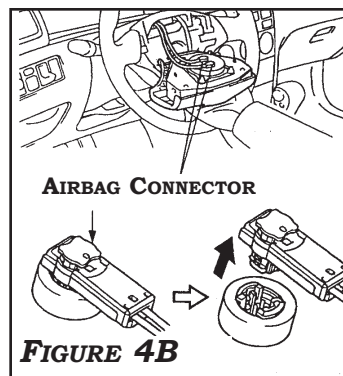
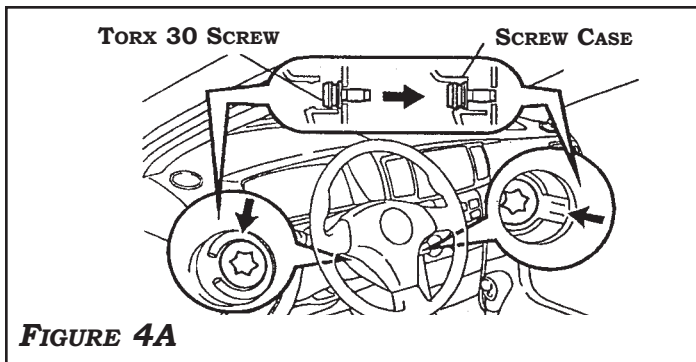
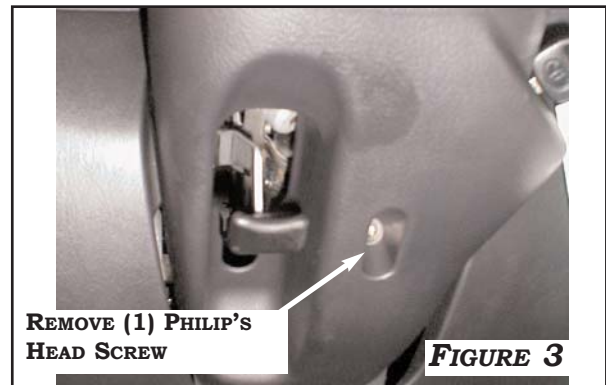
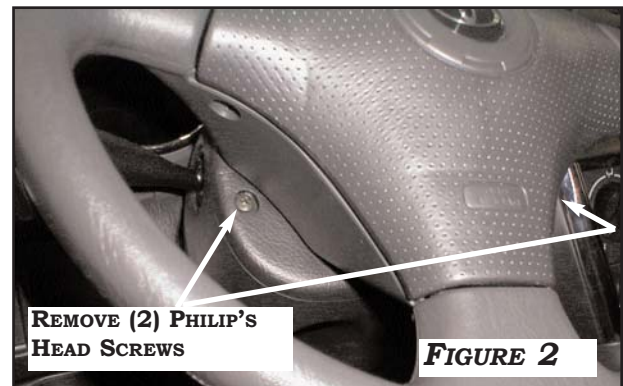
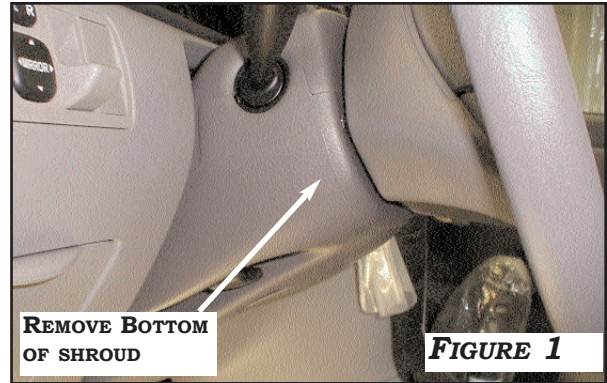

INSTALLATION

CONTROL SWITCH CONTINUED



4. USING THE **SWITCH HOLE CUTTING TEMPLATE, 250-2599**, PLACE THE LOCATER TABS INTO OE CRUISE SWITCH MOUNTING HOLES AND DRILL ONE (1) **5MM (13/64")** HOLE AND TWO (2) **8MM (11/32")**. **FIGURES 6 & 7**



5. USING THE **SWITCH HOLE CUTTING TOOL, 250-2598**, PLACE THE LOCATER TABS INTO OE CRUISE SWITCH MOUNTING HOLES AND WITH 13MM SOCKET, TIGHTEN THE SCREW UNTIL PLASTIC HOLE IS CUT OUT. **FIGURES 8, 9 & 10.**



ENSURE THAT THE MARKS INDICATING THE TOP OF THE CUTTING TOOL ARE FACING UP; THE ANGLE ON THE TOOL SHOULD SILOUETTE THE CURVES OF THE STEERING SHROUD. **FIGURES 8, 9 & 10.**



6. SOMETIMES THE CUTTING DIE MAY GET LODGED IN THE STEERING SHROUD MATERIAL; IN THIS CASE, UTILIZE THE CUTTING EXTRACTION TOOL, **250-2600**, TO REMOVE DIE.

THREAD T-BOLT INTO DIE AS SHOWN IN **FIGURE 11** AND PULL TO REMOVE DIE FROM STEERING SHROUD.

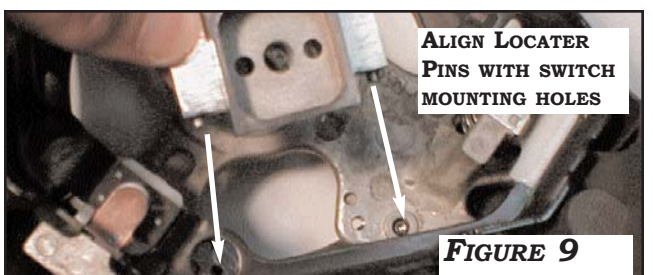
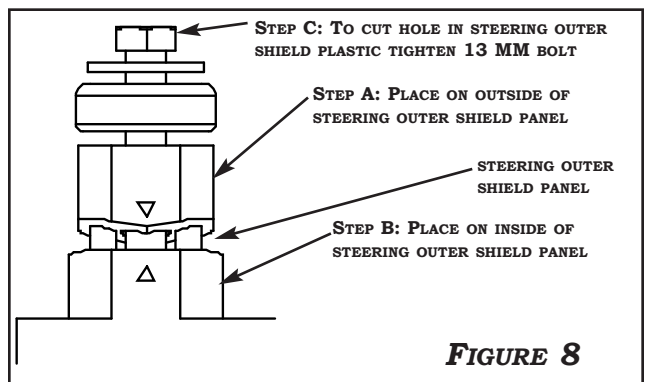
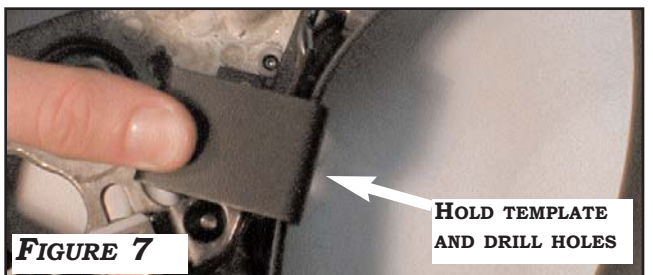
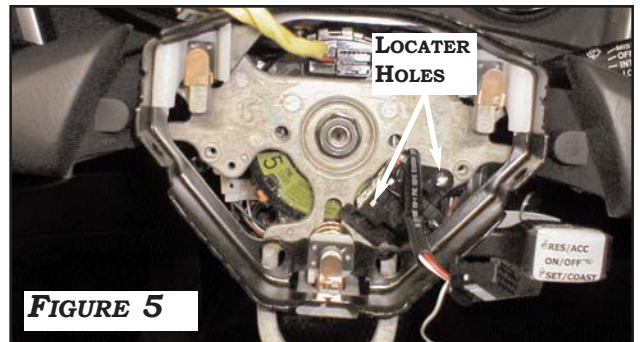

INSTALLATION

CONTROL SWITCH CONTINUED



7. MOUNT CRUISE CONTROL SWITCH WITH TWO (2) TORX 15 SCREWS PROVIDED. REMOVE GROUND TERMINAL AND DUMMY HORN/CRUISE CONNECTOR FROM STEERING WHEEL AND DIS CARD. PLUG IN CRUISE SWITCH CONNECTOR ENSURING TO RECONNECT GROUND TERMINAL. **FIGURE 6 & 12**



8. REINSTALL AIRBAG.

9. UTILIZING INTERFACE CONNECTORS ON MAIN CRUISE HARNESS, MAKE INTERFACE CONNECTION TO HORN/CRUISE CONNECTOR LOCATED AT STEERING SLIP-RING NEAR SWITCH LOCATION AS SHOWN IN **FIGURE 13**.

10. REINSTALL TWO (2) PIECE STEERING WHEEL SHROUD.

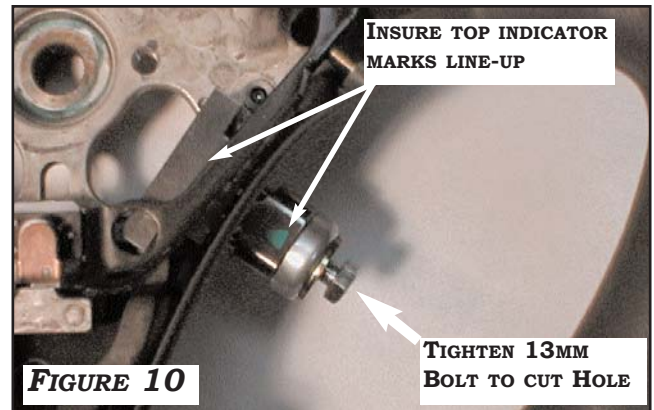

FIGURE 10



REMOVE CUTTING DIE WITH EXTRACTION TOOL

FIGURE 11



FIGURE 13

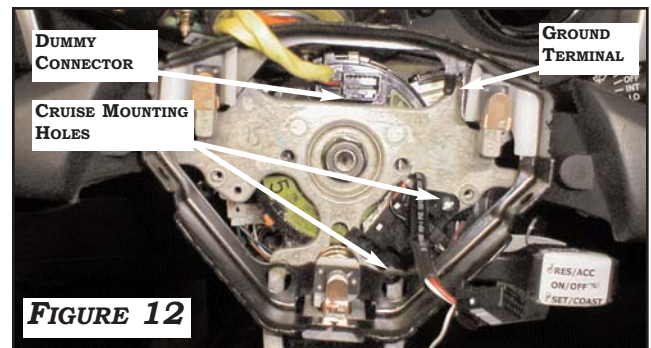

FIGURE 12

CLUTCH SWITCH

FOR MANUAL TRANSMISSION VEHICLES MANUFACTURED AT TMMC

1. RECORD POSITION OF CLUTCH PEDAL IN ITS FREE, UNDEPRESSED POSITION. REMOVE STOP BOLT AND THREAD **CLUTCH SWITCH** SO THAT THE PLUNGER IS COMPLETELY DEPRESSED WHEN THE CLUTCH PEDAL IS IN ITS FREE, UNDEPRESSED POSITION. SECURE **CLUTCH SWITCH** WITH JAM NUT REMOVED FROM THE STOP BOLT. **FIGURE 14**

2. UTILIZE EITHER INSULATED MALE TERMINAL AND T-TAP OR BUTT SPLICE TO CONNECT CLUTCH SWITCH TO VEHICLE FACTORY CONNECTOR:

MATRIX: CONNECTOR IA4 PIN 6, BLUE WIRE AND PIN 7, RED/WHITE WIRE
COROLLA: CONNECTOR IA5 PIN 6, BLUE WIRE AND PIN 7, RED/WHITE WIRE

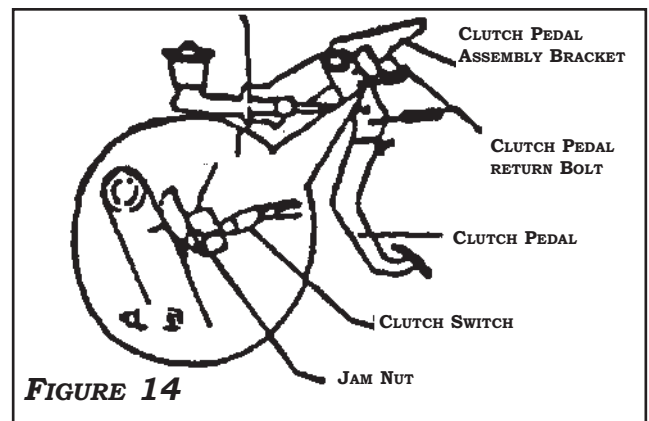

FIGURE 14

REASSEMBLY

1. RECONNECT NEGATIVE BATTERY CABLE AND TORQUE TO 3 FT LBS.

NOTES

NOTES



**Rostra
Precision
Controls, Inc.**