

**07-09 Pontiac Torrent/Equinox
08-09 GM Full Size Vans Cruise Instructions
250-9003**

REMOVE FOLLOWING PARTS:

1. Remove bottom of steering column. Remove plastic shroud (3-7mm bolts). **Figure 1**
2. Remove driver's knee panel (2-7mm bolts). Pull down to release (3 fasteners).

INSTALLING CRUISE CONTROL:

1. Locate black 10 pin plug in the SIR Coil at the top of steering column. **For GM Vans: Locate black 10 pin connector below steering column.** Connect the "Green" wire in the cruise control harness to "Gray" wire in position "D" or "K" of the Black 10 pin plug. **Figure 2**
2. Locate the Black 6 pin plug for the ignition switch. Connect the "Blue" wire in the cruise harness to "Pink" wire in position "1" of the ignition switch plug. **Figure 3**
3. Connect the "Black" wire in the cruise harness to a meter proven ground.

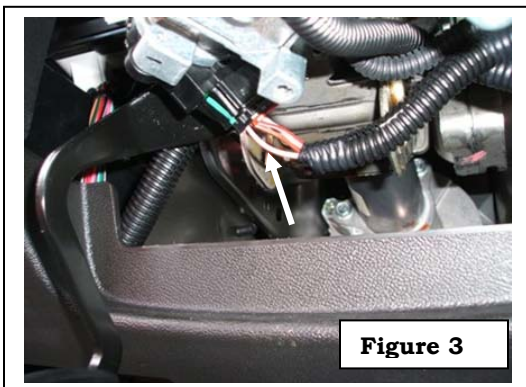
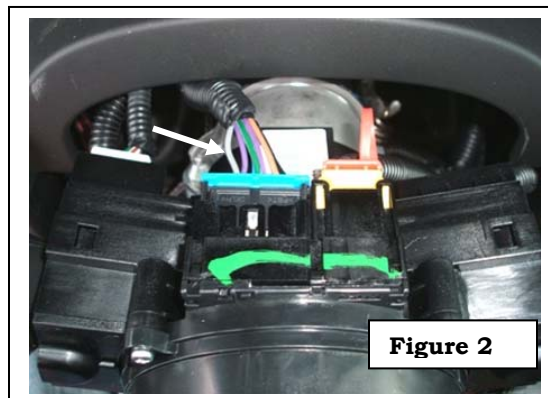
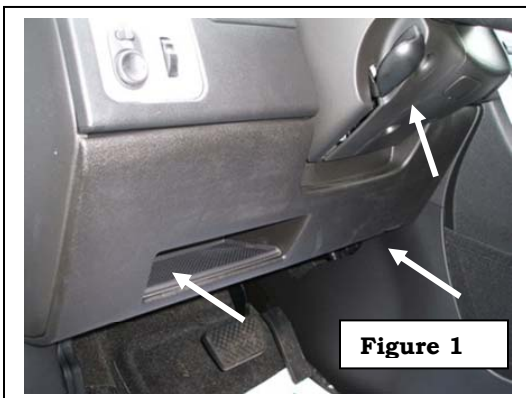

1-800-343-1382

**Please call for technical assistance.
You will need your invoice number.**

INSTALLING CONTROL SWITCH:

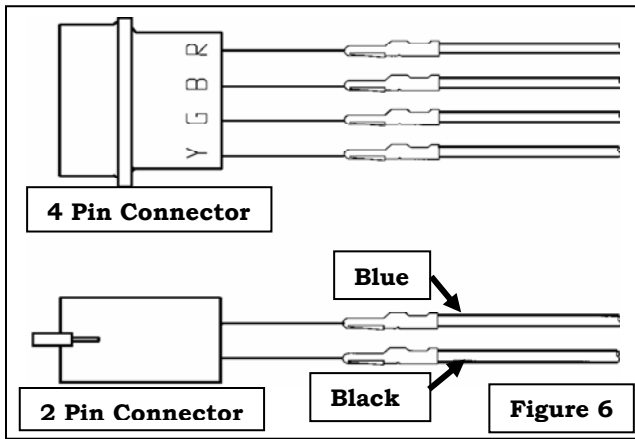
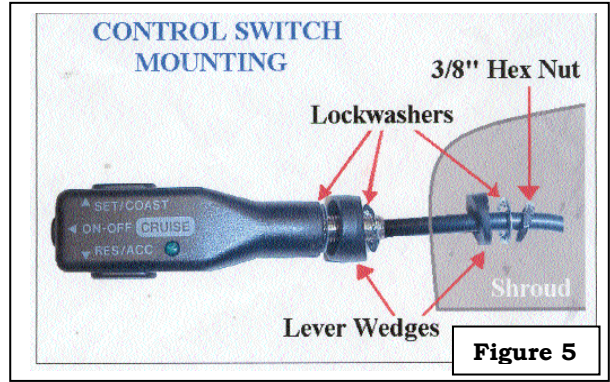

CRUISE CONTROL PROGRAMMING: (Requires TECH II, Candi Module and TIS Computer) **NOTE: GM VANS WILL NOT REQUIRE PROGRAMMING**

1. Reprogramming the BCM:

Turn the ignition to **ON** Plug the Tech II into the vehicle's DLC and turn the Tech II **ON**
From the "Start" menu – Press: **ENTER**
Select: **F1- Service Programming System**
Select: **F0 - Request Info**
Use Soft key to Select: **Continue**
Select: **Chevrolet or Pontiac** (Choose vehicle you are currently working on)
Select: **2007**
Select: **LD TRK, MPV, Incomplete**
Select: **Equinox or Torrent** (Choose vehicle you are currently working on)
Follow On-screen instructions/cautions and use Soft key to Select: **Continue**
Verify that the VIN displayed is "Correct" and Select: **YES**
Turn the ignition **OFF**. Turn the Tech II **OFF** and disconnect it from the DLC
Connect the Tech II to the TIS computer terminal and a power source
Turn the Tech II **ON** and start the TIS SPS Program
Select Diagnostic Tool - Select: **Tech II**
Select Programming Process - Select: **Replace and Reprogram ECU**
Select ECU Location - Select: **Vehicle**
Click: **Next** (Click Next until VIN screen is displayed)
Verify that the VIN displayed is "Correct" for the vehicle. Click: **Next**
Choose Controller- Select: **BCM**
Choose Programming Type - Select: **Normal**
Only **3** Calibration Selections are required to be selected (System, Interior/Exterior Lighting and Power-train Control)
For System Select Calibration choose: # **25828506 – Steering Wheel Control UK3**
For Interior/Exterior Lighting choose: # **25828503 (No Fog Lights)** or #**25828504 (With Fog Lights)**
* Check front bumper for Fog lights or for RPO **T96** (Lamp Fog, Front)
For Power-train Control choose: # **25828488 – Cruise Control K34**
Click: **Next** Summary Screen is displayed
Verify calibration files are correct - then Click: **Next**
After the data upload to the Tech II is completed - Click: **Close**
Disconnect the Tech II from the TIS Computer and re-connect it to the vehicle's DLC
Turn ignition **ON** turn the Tech II **ON**
From the "Start" menu - Select: **ENTER**
Select: **F1- Service Programming System**
Select: **F0 - Program ECU**
Verify the VIN displayed is correct
Follow On-screen instructions/cautions and use Soft key to Select: **Continue**
After the data download is complete (approx. 2 mins.) turn the ignition **OFF** for 10 seconds

2. Calibrating BPP Sensor:

Turn the ignition to ON

Use the Tech II's Soft Key to choose: **Continue**

Press the **Exit** button on the Tech II to return to the Start Screen and Select: **F0 – Diagnostics**

Select: **2007**

Select: **LD, MPV, Incomplete**

Select: **Chevrolet Truck or Pontiac MPV** (Choose vehicle you are currently working on)

Select: **L Body**

Select: **F3 – Vehicle Control System**

Select: **(F) 3.4L V6 LNJ**

Select: **F2 - Module Setup**

Select: **Body Control Module**

Select: **F0 – BPP Sensor Calibration** (Brake pedal position sensor calibration)

The Tech II will prompt you - **DO NOT** touch the brake pedal and insure that the vehicle is in **PARK**

Use the Soft Key to choose: **Continue**

After the procedure is complete, press the **Exit** button on the Tech II

3. Configure Primary Key:

Select: **F1 – Set Up SDM Primary Key in BCM**

Press: **Enter**

Once Primary Key Numbers are Configured the screen will display: Procedure Complete

Press: **Exit**

Turn the ignition OFF Wait 10 seconds and then start vehicle

Return the Tech II to the Main Menu and Select: **Diagnostics**

Select: **2007**

Select: **LD, MPV, Incomplete**

Select: **Chevrolet Truck or Pontiac MPV** (Choose vehicle you are currently working on)

Select: **L Body**

Select: **F3 – Vehicle Control System**

Select: **F0 – Vehicle DTC Information**

Select: **F0 – DTC Display**

After all modules are checked, choose the Soft Key button to choose: **View all DTC's**

Use the Soft Key and the YES button to **Clear all DTC's** from every module

There should be NO Warning lights in the instrument cluster and NO DTC's afterwards

ROAD TEST THE VEHICLE TO VERIFY THE CRUISE CONTROL IS WORKING

The cruise control circuits can be checked with the Tech II. If you build the vehicle into the Tech II and select the **BCM – Data Display – Cruise Control**, you can confirm that the BCM is receiving the correct signal voltages from the cruise lever.